

rotork®

Controls

IQ Range 

**IQ Electric Valve Actuators Including Safety Function Control Board Option
SAFETY MANUAL**



IQ Multi-turn Electric Valve Actuators

Keeping the World Flowing





1. Overview	3
1.1 Overview of Equipment Covered by the Functional Safety Assessment	4
1.2 Safety Manual Overview	4
1.3 Safety Functions	5
1.4 Applicable Actuator Types	5
1.5 IQ Safety Function Control Board Option - Actuator Reliability Data	6
1.6 Safety Function 2 – Reliability Data	6
1.7 IQ Safety Function Control Board Option Operating Principle	7
1.8 Safety Function Priority	7
2. Safety Function Operation	10
2.1 Safety Function 1 – Stayput Operation	10
2.2 Safety Function 2 – ESD Operation	10
3. Design Requirements	11
3.1 Actuator Selection and Sizing	11
3.2 Valve Loading	11
3.3 Actuator Power	12
3.4 Actuator Control	12
3.5 Actuator Indication	13
3.6 Environmental	13
3.7 Safety Instrumented System (SIS) Assessment for SIL 2 and SIL 3 Applications	14
4. Installation	15
4.1 Important Information	15
4.2 Basic Commissioning - Valve Settings	16
4.3 Connecting to the Actuator	16
4.4 Basic Settings – Limits	18
4.5 Close Settings	19
4.6 Open Settings	19
4.7 Secondary Commissioning – Indication Settings	20
4.8 Secondary Settings – ESD	21
4.9 Secondary Settings – Remote Maintain (SF1 only)	21
5. General Safety Function Commissioning	22
5.1 General Safety Function Settings	22
5.2 Safety Function 1 – Do Not Spuriously Operate (or Stayput)	24
5.3 Safety Function 2 – ESD Move on Command	25
5.4 Dual Safety Function – SF1 Priority	26
5.5 Dual Safety Function – SF2 Priority	26
5.6 Interrupter Timer	27
6. Verification	27
6.1 Valve Setting Verification	27
6.2 Safety Function 1 - Stayput Verification	28
6.3 Safety Function 2 - ESD Setting Verification	28
6.4 Proof Testing – Safety Function 2 - ESD	29
7. Tamper Prevention	30
8. General Maintenance	31

Actuator Safety Manual

⚠ This safety manual defines the setup, installation, operation and maintenance of the IQ actuator including the Safety Function Control Board option, designed for Safety Instrumented Systems requiring Functional Safety Integrity Levels (SIL) 2 or SIL 3 to Standard IEC61508-2:2010.

Applicable Safety Functions:

1. **Stayput** - not to move spuriously.
Also known as Motor Enable (permissive) and/or
2. **ESD** – to move on demand.

SIRA Functional Safety Approval Certificate:
SIRA FSP 15001

⚠ WARNING: Failure to apply the procedures detailed in this manual will invalidate the safety function certification.

⚠ WARNING: This Safety Manual must be read and implemented in conjunction with PUB002-039 – IQ3 Safe Use, Installation and Maintenance manual.

Glossary:

SIL	Safety Integrity Level
SIS	Safety Instrumented System
ESD	Emergency Shut Down
Stayput	Remain in place or Do Not Move
SF1	Safety Function 1 (Stayput)
SF2	Safety Function 2 (ESD)
PVST	Partial Valve Stroke Test
PST	Partial Stroke Test
Powered Operation	Movement initiated by an electrical command
PFD	Probability of Failure on Demand
MTTR	Mean Time to Repair
DCS	Distributed Control System
PLC	Programmable Logic Controller
IT	Interrupter Timer
PFH	Probability of failure per hour
SC2	Systematic Capability 2 (for use with SIL2 equipment)
SC3	Systematic Capability 3 (for use with SIL3 equipment)



1.1 Overview of Equipment Covered by the Functional Safety Assessment

The IQ range is a family of electric valve actuators categorised by output torque and speed at a specified supply voltage, designed to provide local and remote operation of industrial valves and dampers of all types. This safety manual is applicable only to IQ actuators containing the Safety Function Control Board option.

As well as providing normal process control of valves, remote control may include Emergency Shut Down (ESD) operation to open or close a valve or a Motor Enable input to ensure a valve does not move spuriously, as a priority.

The IQ design consists of a gear case enclosure and electrical covers, cast in aluminium alloy, which are bolted to a cast iron base providing connection to the valve or gearbox. Output movement is derived from an electrical motor driving a worm and wheel gear running in an oil bath. The motor is controlled by a special, optional Safety Function Control Board.

All IQ actuators include a hand/auto clutch engaged hand wheel for manual operation in case of loss of power supply and feature local and remote control selectors, *Bluetooth*[®] interface, position monitoring, torque sensing and control/indication I/O. Configuration of the actuator settings is provided via a high resolution LCD display and supplied proprietary Rotork *Bluetooth*[®] Setting Tool Pro.

IQ3 actuators are designed to operate as standard between the temperature ranges of -30 to 70°C. Low temperature options can also be offered down to -40°C and all IQ actuators will have an enclosure rating to IEC60529 of IP66 and IP68. In addition, IQ can be provided with builds certified for use in hazardous areas under the ATEX directive, international Standard IEC Ex, North American NFPA –NEC and CSA standards (other national standard builds are also available).

The IQ3 actuators applicable to functional safety requirements Stayput (Safety Function 1) and/or ESD (Safety Function 2) shall be powered by a three-phase electrical supply only. The actuator must be powered for the Safety Function to be performed.

A full detailed specification for IQ3 can be found in publication PUB002-038.

1.2 Safety Manual Overview

This document is the Safety Manual for the IQ actuator, which can be identified and categorised by a specific wiring diagram to provide certified reliability for use in safety instrumented systems requiring SIL 2 or SIL 3 utilising the Motor Enable and ESD inputs. It contains detailed information on design requirements, installation, commissioning and verification of the actuator within the Safety Instrumented System (SIS) plus through-life operation, proof testing and maintenance requirements. It also provides guidance on indication settings that may be used but are not part of the safety function of the actuator.

It is the responsibility of the user to determine whether the measures contained within this document are sufficient or necessary.

A list of documents applicable to SIRA assessment approval are listed on the SIL certificate FSP 15001.

1.3 Safety Functions

The following safety functions are available with actuators containing the Safety Function Control Board option (refer to actuator circuit diagram):

Safety Function 1 - Stayput

- The actuator shall not move without a valid Motor Enable control signal combined with a valid remote Open, Close or ESD signal
- This is a high-demand mode safety function

Safety Function 2 - ESD

- The actuator shall operate as configured (Open, Close or Stayput) with a valid ESD control signal
- This is a low-demand mode safety function

Safety Functions 1 and 2 may be combined with either one configured to have priority – refer to section 5.4 and 5.5.

1.4 Applicable Actuator Types



IQ 3-phase actuators containing the Safety Function Control Board option only, designed for isolating or regulating valve duty with a SIS Safety Function 1 (Stayput) and/or Safety Function 2 (ESD) requirement. Mid-travel positioning is possible under normal operating conditions.

Control

Safety Functions 1 and 2 may only be implemented using hardwired signals within the range 14-60 VDC. Actuators may include control interface options for systems such as *Pakscan*[™], Profibus[®], Foundation Fieldbus[®] etc., however such systems do not fall within the scope of the safety functions applicable to this manual. Such control options may be used for process control/indication; however, Safety Function 1 and 2 can only be implemented by hardwired Motor Enable and ESD signals.

Indication

Only the SIL alarm relay (refer to wiring diagram) falls within the scope of the reliability given in this manual. Monitor relay, “S” Contacts, CPT analogue position indication and those derived by network systems do not. For valve position indication required for the SIS, this must be derived directly from the valve stem (obturator) using certified contacts or other means. Such means do not fall within the scope of this safety manual.

Safety Function 1 and 2

Type	Operation	Power supply	Duty rating	Starts/hr
IQ	Multi-turn isolating & ¼ turn isolating	3 phase only	S2/S3 - 25%, Class A & B	60



1.5 IQ Safety Function Control Board Option - Actuator Reliability Data

The following reliability data covers the complete actuator up to and including the actuator output drive assembly. It does not include the valve, valve drive components or second stage gearboxes.

Reliability data shown below is for safety function 2. For safety function 1 data, refer to SIRA certificate FSP 15001.

1.6 Safety Function 2 – Reliability Data

The integrity/reliability of the electrical power supply and user derived control signals are not included in the actuator reliability assessment.

Approval for SIL applications based on the stated periods. Users must ensure these intervals are not exceeded in service.

SIL capability of the subject equipment can be increased by introducing a powered operation at regular intervals. For information on PFD figures when using a powered operation, refer to the table in section 6.4.3.

Powered Operation - A Powered Operation is a verified movement of the actuator, following a valid Local or Remote command, in both the Open and Closed direction.

Verifying the Powered Operation - You can verify a Powered Operation locally or remotely*. Local powered operations must be verified at the actuator through visual observation of movement. Remote Powered Operations can be verified by using SIL Relay indication.

*Powered Operation must be confirmed locally for SIL software versions 101, and 103.

Example – Actuator configured for a Close SF2 action

If the actuator receives a valid REMOTE CLOSE command followed by a REMOTE OPEN command, an energised SIL Relay will confirm that the actuator has moved in the correct direction, therefore verifying a Powered Operation has been completed.

If the actuator receives a valid LOCAL CLOSE command the operator can verify movement visually, thus confirming the Power Operation has been completed.

The list of faults detected by the SIL Relay is below:

- Removing power to the actuator
- Internal electronics error
- SIL Config Mode – If the actuator is in commissioning mode
- SIL Deactivated – If the actuator has not been set up
- EEPROM Error – Faulty EEPROM hardware has been detected
- Thermostat Trip detected
- SIL Wrong Direction – If the actuator tried to do an ESD but detected that the direction is wrong
- Configuration error detected
- Stalled - For SF2 only. No movement detected by the actuator, following a valid remote or local command

NOTE: For actuator size (1 to 5) breakdown refer to the table in section 6.4.3.

The assessment of the IQ3 SIL Actuator sizes 1 to 5 with the use of the powered operation test such as (PVST = 6 months) achieved the following results for safety function 2.

Safety Function: The actuator shall operate as configured (Open, Close or Stayput) with a valid ESD control signal.						
Note: The configured actions (Open, Close or Stayput) are pre-determined by the user.						
Summary of IEC 61508-2 Clauses 7.4.2 and 7.4.4	IQ3 SIL Size 1	IQ3 SIL Size 2	IQ3 SIL Size 3	IQ3 SIL Size 4	IQ3 SIL Size 5	Verdict
Architectural constraints & Type of product A/B	HFT=0 (1001)					Type B
Safe Failure Fraction (SFF)	98%	97%	97%	98%	97%	SIL2
Random hardware failures: [h ⁻¹]	λ_{DD} λ_{DU} 7.34E-07 1.70E-06	λ_{DD} λ_{DU} 7.68E-07 1.96E-06	λ_{DD} λ_{DU} 7.68E-07 1.88E-06	λ_{DD} λ_{DU} 7.84E-07 1.77E-06	λ_{DD} λ_{DU} 7.84E-07 2.51E-06	
Random hardware failures: [h ⁻¹]	λ_{SD} λ_{SU} 1.98E-05 6.62E-05	λ_{SD} λ_{SU} 8.24E-06 6.41E-05	λ_{SD} λ_{SU} 8.24E-06 6.45E-05	λ_{SD} λ_{SU} 8.18E-06 6.35E-05	λ_{SD} λ_{SU} 8.18E-06 6.25E-05	
Diagnostic coverage (DC)	30%	28%	29%	31%	37%	No PVST
PFD _{AVG} @ PTI = 1 yr, MTTR=24hrs, no PVST	7.5E-03	8.7E-03	8.3E-03	7.8E-03	1.1E-02	
PFD _{AVG} @ TPVST = 6 months, MTTR=24hrs, with PVST	4.0E-3	4.6E-3	4.4E-3	4.1E-3	5.8E-3	SIL2
Hardware safety integrity compliance	Route 1H					
Systematic safety integrity compliance	Route 1s See report R70004934B-IQ3SIL_V1.0					
Systematic Capability (SC1, SC2, SC3, SC4)	SC2 (HFT:0) ; SC3 (HFT:1) See report R70004934B-IQ3SIL_V1.0					
Hardware safety integrity achieved	Sizes:1,2,3,4 & 5 achieved SIL 2 (low demand, HFT=0) For TPVST = 6 months					

1.7 IQ Safety Function Control Board Option Operating Principle

The actuator has two operational safety functions which may be applied individually or combined dependent on the required Safety Instrumented System (SIS) safety function. The safety function applied will be determined by the type of control required and therefore by the remote control signal type:

Safety Function	Action	Control Signal Type
1	To Stayput	Removal of the Motor Enable signal
2	To perform the commissioned ESD Safety Function	Removal of the ESD signal
1 & 2	To Stayput, else to perform the commissioned ESD Safety Function	Removal of the Motor Enable signal / ESD signal (motor enable has priority)
2 & 1	To perform the commissioned ESD Safety Function, else to Stayput	Removal of the ESD signal / Motor Enable signal (ESD has priority)

1.8 Safety Function Priority



1.8.1 Safety Function 1 – Stayput: Motor Enable Operating Principle

Safety Function 1 Stayput is high demand. Configure Safety Function to SF1.

The Motor Enable signal input line is used to implement a control permissive. The design principle is therefore that the Motor Enable signal is applied ONLY when open or closed operation is authorised and intended. When operation is not authorised or intended (Stayput), the Motor Enable signal must be removed. De-energising the Motor Enable input line while the actuator is moving will cause the actuator to stop.

By controlling the Motor Enable input line, the user determines if and when control can take place. The Motor Enable input line may therefore be controlled from the Safety Instrumented System (SIS) logic solver while the remote control signals may be derived from the Basic Process Control System (BPCS).

The Motor Enable input line provides demonstrable reliability levels as assessed independently by SIRA and referenced in SIRA certificate FSP 150001.

Safety Function 1 – Stayput configurable options

Motor Enable can be configured to implement Safety Function 1 – Stayput as follows:

- During Local and Remote control
- During Remote Control only



1.8.2 Safety Function 2 - ESD Operating Principle

Safety Function 2 - ESD is low demand. Configure Safety Function to SF2.

The remote ESD signal input is used to implement the configured SIL action; to Open, to Close or to Stayput. A valid ESD signal comprises removal of a DC voltage from the ESD terminal; i.e. a remote ESD contact breaking. Refer to the circuit diagram for connection details. To implement ESD, the signal must be removed for the duration of the ESD event (valve stroke or stayput period). Refer to wiring diagram.

Safety Function 2 – ESD configurable options

ESD can be configured to implement Safety Function 2 - ESD as follows:

- During Remote, Stop and/or Local control
- During Remote control only
- To Open, to Close or to Stayput
- To override an active motor thermostat trip (relevant hazardous area/electrical certification invalidated)
- ESD after a configurable delay period
- Seating action
- During local or remote control error state

1.8.3 Safety Function 1 and Safety Function 2 (Stayput > ESD): Operating Principle

Safety Function 1 - Stayput is high demand, Safety Function 2 - ESD is low demand. Configure Safety Function Priority to SF1.

Safety function 1 - Stayput has priority over Safety Function 2 - ESD. Refer to 1.8.1 for Stayput operating principle. The configured SIL ESD action cannot be implemented without a valid Motor Enable signal present. ESD has priority over Local and Remote, Open and Close operation (Configuration dependent).

Safety Function 1 and Safety Function 2 – Configurable options

Motor Enable can be configured to implement Safety Function 1 - Stayput as follows:

- During Local and Remote control
- During Remote control only

ESD can be configured to implement Safety Function 2 - ESD as follows:

- During Remote, Stop and/or Local control
- During Remote control only
- To Open, to Close or to Stayput
- To override an active motor thermostat trip (relevant hazardous area/electrical certification invalidated)
- ESD after a configurable delay period
- Seating action
- During local or remote control error state

1.8.4 Safety Function 2 and Safety Function 1 (ESD > Stayput): Operating Principle

Safety Function 2 - ESD is low demand, Safety Function 1 - Stayput is high demand. Configure Safety Function Priority to SF2.

Safety function 2 - ESD has priority over Safety Function 1 - Stayput. Refer to 1.8.2 for ESD operating principle. The configured SIL ESD action will be implemented with or without a valid Motor Enable signal present. Motor Enable still has priority over Local and Remote, Open and Close operation (Configuration dependent).

Safety Function 1 and Safety Function 2 – Configurable options

ESD can be configured to implement Safety Function 2 - ESD as follows:

- During Remote, Stop and/or Local control
- During Remote control only
- To Open, to Close or to Stayput
- To override an active motor thermostat trip (relevant hazardous area/electrical certification invalidated)
- ESD after a configurable delay period
- Seating action
- During local or remote control error state

Motor Enable can be configured to implement Safety Function 1 - Stayput as follows:

- During Local and Remote control
- During Remote control only



2. Safety Function Operation

2.1 Safety Function 1 – Stayput Operation

The table below provides an overview of the operating response of the IQ to local/remote control commands and the effect Motor Enable signal status has in their process operation. It also provides applicable actuator SIL relay status indication.

SF1					
Override Local	Control Mode	Applied Signal	Motor Enable Input	Action	SIL Relay Contact
On	Local/Remote	Open/Close	Applied	Local/Remote Operation	Closed
On	Local/Remote	Open/Close	Removed	No Operation	Closed
Off	Local	Open/Close	Applied	Local Operation	Open
Off	Local	Open/Close	Removed	Local Operation	Open
Off	Remote	Open/Close	Applied	Remote Operation	Closed
Off	Remote	Open/Close	Removed	No Operation	Closed

Table 2.1

2.2 Safety Function 2 – ESD Operation

The table below provides an overview of the operating response of the IQ to ESD control commands. It also provides applicable actuator SIL relay status indication.

SF2						
Override Local	Override Stop	Control Mode	Applied Signal	ESD Input	Action	SIL Relay Contact
On	On	Local/Stop/Remote	Open/Close	Removed	Configured ESD	Closed
On	Off	Local/Remote	Open/Close	Removed	Configured ESD	Closed
On	Off	Stop	Open/Close	Removed	No Operation	Open
Off	On	Stop/Remote	Open/Close	Removed	Configured ESD	Closed
Off	On	Local	Open/Close	Removed	Local Operation	Open
Off	Off	Local	Open/Close	Removed	Local Operation	Open
Off	Off	Stop	Open/Close	Removed	No Operation	Open
Off	Off	Remote	Open/Close	Removed	Configured ESD	Closed

Table 2.2

3. Design Requirements

3.2 Valve Loading

3.1 Actuator Selection and Sizing

The selection of actuator type and size is dependent on the valve type and its required operating forces (torque and/or thrust). It is the responsibility of the valve manufacturer/supplier to specify the required valve type and operating forces. For retrofit applications, it is the responsibility of the design engineer to specify the valve type and its operating forces. Actuator performance data is provided on the unit nameplate and on its individual test certificate.

The following selection and sizing design principles/conditions are applied and the installer must verify their suitability for the selected valve in performing its safety function within the SIS:

- Refer to essential health and safety information provided in PUB002-039.
- The supplied actuator has been sized based on its rated torque/thrust being at least equal to the required valve operating torque/thrust for the specified operating time.
- No additional safety factors have been added unless expressly requested.
- The actuator must only be fitted to the valve selected at the design stage.
- Changes in process conditions to those specified at the design stage may affect actuator sizing requirements and must be referred to the valve maker/supplier or design engineer.
- Valve operation under the specified process operating conditions must be verified.

NOTE: The following design principles/conditions must be applied

- The valve and/or valve motor components must be capable of safely withstanding the supplied actuator stall torque and/or developed thrust at stall torque.
- For design purposes, IQ stall torque shall be considered to be at least 2 times supplied actuator/actuator-gearbox combination rated torque.

The effect of valve loading does not fall within the scope of this safety manual. It is the responsibility of the SIS design engineer to verify that the valve load imposed on the actuator or actuator-gearbox combination is not capable of mechanically back driving it and therefore causing valve movement when the actuator is at rest. For linear gate valves, the stem thread lead efficiency must be sufficiently low to ensure a self-locking capability under worst case process conditions (thrust, temperature and pressure).

For part turn valves, including dampers, the efficiency of the worm gearbox should be sufficiently low to ensure the actuator cannot be back driven. Note that under vibration, no worm gear can be considered self-locking under all circumstances and a mechanical brake may be considered necessary.



3.3 Actuator Power

The actuator electrical power supply integrity does not fall within the scope of this safety manual. It is the responsibility of the SIS design engineer to ensure the integrity of the actuator power supply meets the requirements of the target SIL for the SIS. For actuator electrical supply data and requirements, refer to publication PUB002-057. Electrical power is required for the safety function to be performed.

3.4 Actuator Control

Refer to the circuit diagram and control connection drawing supplied with the actuator.

In order to meet the requirements of SIL 2 for Safety Function 1, the actuator must be controlled for opening and closing using the appropriate control signal input and Motor Enable signal. The application of only the control signal is invalid and will display a "MOTOR ENABLE LOSS" alarm on the actuator.

For Safety Function 2, a single, standing ESD signal derived from a normally Closed contact (break to ESD) is required. ESD operation will override any existing remote Open or Close signal while active in order to carry out the configured ESD action (Open, Close or Stayput). ESD will not override an actuator selected to stop or local control unless configured to do so.

Control signal integrity does not fall within the scope of the actuator reliability assessment. User must ensure the integrity of control signals meet the requirements of the target SIL for the SIS.

Network Option Control

If a network option field unit has been specified, (Modbus®, Profibus®, Foundation Fieldbus®, *Pakscan*™ etc.), the hardwired Motor Enable/ESD signal is intended to be operated by a logic solver that is part of the SIS.

Remote Hand Station

Although the Remote Hand Station is compatible with SIL, all SIL settings and configurations (such as local overrides) apply to the actuator only. Commissioning of SIL actuators can only be carried out local to the actuator.

The Safety Function Control Board option includes fault status "SIL" relay indication – refer to actuator circuit diagram for connection details. For status indication refer to tables 2.1 and 2.2. This relay provides a status of the actuator's ability to perform the configured safety function.

Indication contacts

The actuator has 4 configurable contacts, S1 to S4 available for indication including Open and Closed position limit indication and intermediate position indication (configurable). A full list of available functions is provided in publication PUB002-040.

Analogue 4-20 mA position indication

Where the CPT option is fitted, a 4-20 mA signal is available for analogue position indication - refer to actuator circuit diagram.

Monitor relay

The monitor relay will indicate one or more of the following conditions:

- Loss of one or more of the power supply phases
- Loss of control circuitry supply
- Actuator selected for Local control or Local stop*
- Thermostat tripped
- Internal failure
- Compromised SIL action

* The monitor relay is configurable for Availability or Fault. If set to fault, the monitor relay will ignore the position of the Local / Stop / Remote selector. Refer to actuator circuit diagram for connections.

Compromised SIL action is defined as a situation where the SIL action is performed for the configured run time due to a fault with the position or torque sensor.

Note: Indication outputs S1 to S4, Monitor Relay and the CPT analogue position signal do not fall within the scope of the actuator reliability assessment. The user must ensure the integrity of indication meets the requirements of the SIL target for the SIS. If necessary, limit position indication should be derived from certified devices external to the actuator and derived directly from the valve stem (obturator).



The environmental conditions in respect of enclosure rating, temperature, vibration (seismic and plant induced) etc. must not exceed those stated in the actuator specification. Refer to PUB002-038 for general information and the actuator nameplate and test certificate for details. Temperature range for applicable actuators is -40 to +70°C. Operation outside these ambient temperatures will invalidate the safety assessment approval.

For hazardous locations, the actuator enclosure certification must meet the requirements of the location in respect of zone, gas group and temperature "T" rating. Refer to actuator nameplate.

The actuator is fit for use in a SIS requiring SIL 2 in a 1oo1 configuration for Safety Function 1 - Stayput and/or Safety Function 2 – ESD providing the instructions contained in this manual are fully implemented. It is the responsibility of the SIS design engineer to carry out an overall SIL calculation of the SIS. The IQ3 is also suitable for use in a SIL3 application in a 1oo2 configuration. The following notes should be followed.

Notes:

1. It is the responsibility of the system integrator to ensure that sufficient independence between the IQ3s in redundant mode is achieved to eliminate any common cause failure due to a single, common power supply or motor enable signal.
2. The PFD calculation shown in this section for redundant mode uses a beta factor of 5% assuming a complete independent functionality of each IQ3 is configured.
3. The product systematic capability is SC2. In accordance with IEC 61508 part 2 clause 7.4.3, the maximum systematic capability that can be claimed is SC3 for a redundant system having satisfied the requirement of independence as detailed above.
4. Any installation, setup or calibration of a redundant system should be carried out independently. E.g. maintenance of one IQ3 should be carried out and completed before starting the other.
5. In a redundant system, padlocking of the control selectors of hand/auto lever should be achieved with independent padlock and key for each IQ3.
6. Independence of software of the IQ3 is also verified against IEC 61508 part 3, sections 7.4.2.8 & 7.4.2.9.

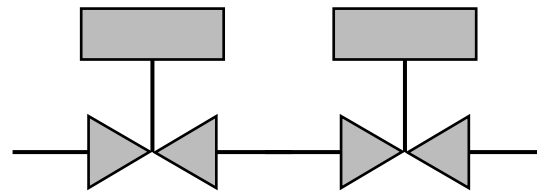

Fig 1. 1oo2 – Process Valve Isolation

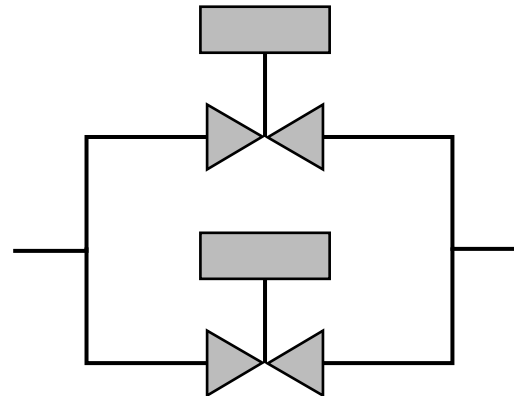

Fig 2. 1oo2 – Process Valve Bypass

Data in the table below is only applicable for 1oo2 actuator configurations.

Parameter	Size 1	Size 2	Size 3	Size 4	Size 5
Proof Test Interval (Hours)	8760	8760	8760	8760	8760
Type A/B	Type B	Type B	Type B	Type B	Type B
Safe Failure Fraction	98%	97%	97%	98%	97%
PFD	4.50E-04	5.30E-04	5.00E-04	4.70E-04	6.90E-04
SIL Capability (Low Demand Mode)	SIL3	SIL3	SIL3	SIL3	SIL3



IMPORTANT: All installations must be carried out by an appropriately trained or competent person, in accordance with any local electrical, health & safety and hazardous area legislation. Refer to publication PUB002-039 for basic Safe Use and Installation / maintenance.

It is the responsibility of the end user to ensure the commissioning engineer is trained in Functional Safety to a suitable level.

Commissioning must be completed and/or verified under any of the following circumstances:

- When the actuator is installed on to the valve for the first time.
- When valve & actuator are installed into the process for the first time.
- When the actuator has been mechanically disconnected from the valve for any reason.
- When the actuator has been physically disconnected from the electrical supply.
- When the phase rotation has or may have changed.
- When any actuator settings have been adjusted or changed.
- When process conditions change beyond those defined by the original commissioned application.

The actuator is dispatched with the Safety Functions disabled, allowing the valvemakersupplier and site installer to set and test basic operational settings required by the valve. Only after these settings and any secondary indication settings have been made and verified should the Safety Function(s) be set if required.

Note: To complete setup of Safety Function 2 (ESD), the remote ESD circuit must be connected and energised.

The following table provides the necessary commissioning steps, in the order that must be followed, with the relevant section of instruction and the responsible organisation (or their nominated agent):

Step	Instruction	Responsibility
1	Set basic actuator settings (Section 4.2)	Valvemaker / End User
2	Verify valve setup (Section 4.3)	Valvemaker / End User
3	Set basic actuator settings (Section 4.2)	End User
4	Set secondary actuator settings (Section 4.7, 4.8 and 4.9 (if applicable))	End User
5	Safety Function Commissioning (Section 5)	End User
6	Set Configuration (Section 5)	End User
7	Verify configuration (Section 5)	End User
8	Activate SIL (Section 5)	End User
9	Dual Safety Function priority validation (Section 5.4 and 5.5)	End user

Note: The actuator is despatched with the Safety Functions disabled to allow basic setting configuration. Refer to section 4.2.

The following procedures must be followed in order. The configuration must be set as specified by the valvemakersupplier and/or the responsible design engineer.

The setting tool is provided to make settings. For instructions on how to connect to an actuator using the Setting Tool, please refer to PUB002-039, section 8.1

Commissioning

All actuator settings, datalogger and asset management data is accessed using the supplied Rotork *Bluetooth*® Setting Tool Pro. Status and alarm data in addition to that shown on the home screen can also be accessed.

⚠ WARNING: THE CONTROL COVER MUST NOT BE REMOVED; NO USER CONFIGURABLE SETTINGS ARE AVAILABLE WITHIN THE CONTROL ENCLOSURE. THE CONTROL COVER IS SEALED BY A QUALITY LABEL WHICH IF BROKEN MAY INVALIDATE WARRANTY.

This instruction details the basic settings that must be completed before the actuator is put into service.

⚠ WARNING: ELECTRICAL OPERATION MUST NOT TAKE PLACE UNTIL THE BASIC SETTINGS HAVE BEEN MADE AND CHECKED.

The basic settings affect the correct operation of the valve by the actuator. If the actuator has been supplied with the valve, the valvemakersupplier may have already made these settings.

Settings and operation must be verified by electric operation and function test of the actuated valve.

For instruction on control and indication settings and for information on diagnostics refer to PUB002-040.

Rotork Setting Tool incorporating *Bluetooth* wireless technology (Rotork *Bluetooth*® Setting Tool Pro – BTST) is shown below. It is identified by the key symbols being clear and a clear seal between the top and bottom casings.

The Infra-red only tool has filled yellow keys and a yellow seal between casings.

The Rotork *Bluetooth*® Setting Tool Pro with the relevant navigation and configuration keys is shown below.



The default security level for connecting to the actuator is by infra-red *Bluetooth* initiation. This requires that the user is at the actuator within 0.25 metre distance and in direct line of sight of the display.

Point the setting tool at the actuator display window and press key.

The Setting Tool will automatically connect using Bluetooth which takes up to 5 seconds and when connected will be indicated by blue lights illuminating on the tool and in the actuator display window. Once connected, the tool can be used without pointing it at the actuator display window.

Bluetooth connection will be maintained while setting tool key commands are made. After a period of 6 minutes with no key commands, *Bluetooth* connection will be turned off, the setting tool and display blue lights will go out. To manually turn off *Bluetooth* connection at any time, press the and keys together.

All actuator settings can be viewed with the actuator selected to Local, Stop or Remote.

If any attempt to access the settings menu is detected, the following warning will appear to remind the user to read the Safety Manual (this document) before attempting to change any settings:



To change an actuator setting, the actuator must be selected to Local or Stop and a correct password entered.

If the actuator is selected to Remote and a setting is selected, the following warning will be displayed:

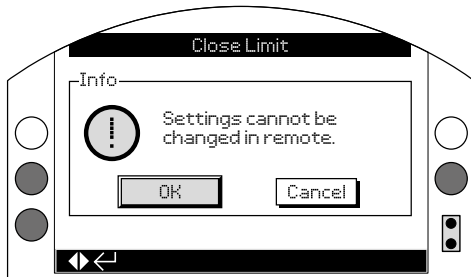

Select **OK** to return to settings screen.

With the actuator selected to Local or Stop and when any function is selected, the Password screen will be displayed:

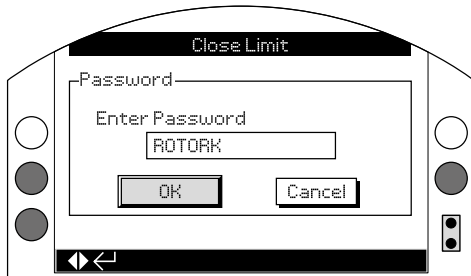

The factory set default password **ROTORK** is displayed and the **OK** key is highlighted.

Press the **Enter** key.

The setting screen will again be displayed. The example below shows **Settings – Limits – Close Settings** with the function **Action** highlighted:

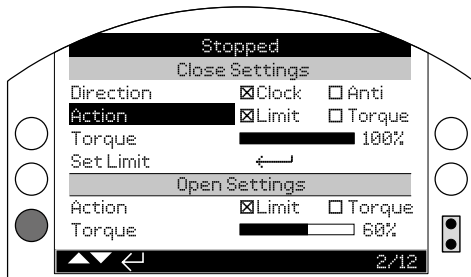

Press the **Enter** key to select.

The function and its setting option or range will then be highlighted:

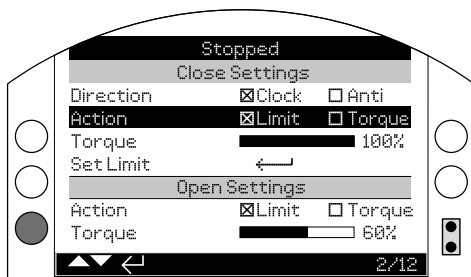

If the user does not wish to change the function value, press the back button to escape without changing.

Use the **Left** or **Right** arrow keys to change the setting to the required value, the example below shows a close action of **Torque** having been selected:

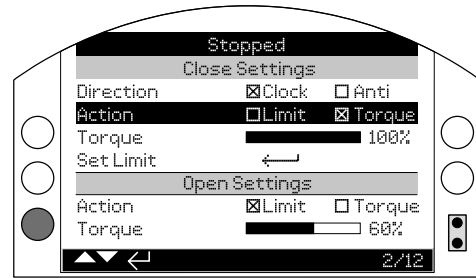

Press the **Enter** key to select.

The highlight will return to the function name only and its stored setting will be displayed:

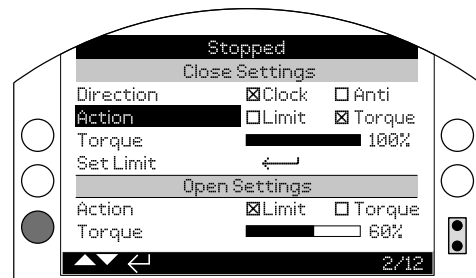

The password will be requested the first time a function is selected. Once correctly entered, the password will not be required to be entered again for the duration of setting tool communication with the actuator. Other functions can be set as required.

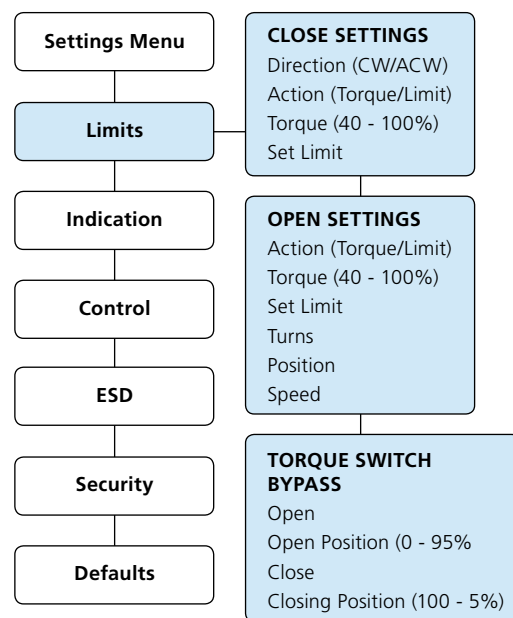

IMPORTANT: Before commissioning commences, the user / commissioning engineer must verify the firmware version of the SIL control PCB. The version should be V101, V103 or V104. Refer to actuator test certificate for the SIL firmware or contact Rotork quoting the actuator serial number.

Settings and operation must be verified by electric operation and function test of the actuated valve. Connect to the actuator as described in Section 4.3. From the Position display home screen press the key. The main menu will be displayed. Navigate to Settings using the keys and press to select.

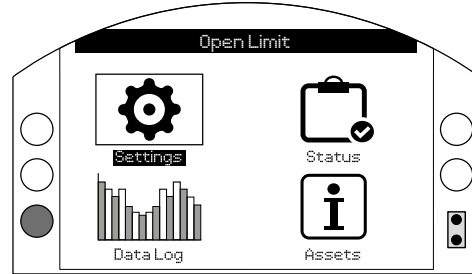

The settings menu will be displayed:

Settings	
Limits	
Indication	
Control	
ESD	
Security	
Defaults	

Navigate to Limits using the keys and press to select.

The setting first selected to be changed will require a password to be entered – refer to section 4.3.

The limit settings are shown below with their factory default values:

Limits	
Close Settings	
1 / 15	Direction <input checked="" type="checkbox"/> Clock <input type="checkbox"/> Anti
2 / 15	Action <input checked="" type="checkbox"/> Limit <input type="checkbox"/> Torque
3 / 15	Torque <input type="text" value="40%"/>
4 / 15	Set Limit
Open Settings	
5 / 15	Action <input checked="" type="checkbox"/> Limit <input type="checkbox"/> Torque
6 / 15	Torque <input type="text" value="40%"/>
7 / 15	Set Limit
8 / 15	Turns <input type="text" value="25"/>
9 / 15	Position <input type="text" value="95.0"/>
10 / 15	Speed <input type="text" value="40%"/>
Torque Switch Bypass	
11 / 15	Opening <input type="checkbox"/> On <input checked="" type="checkbox"/> Off
12 / 15	OP. Bypass Pos <input type="text" value="10%"/>
13 / 15	Closing <input type="checkbox"/> On <input checked="" type="checkbox"/> Off
14 / 15	CL. Bypass Pos <input type="text" value="90%"/>
Auto Limit Setting	
15 / 15	Auto Set Limit
1 / 15	

Function Close Direction (1 / 15) is shown highlighted. Use to scroll through functions. Functions will be highlighted in turn.

1 / 15 Close Direction

Function sets the direction required to close the valve. Manually operate the actuator and valve to establish closing direction.

Press to select Close Direction function. Use or to check required setting. Press to set.

2 / 15 Close Action

The actuator can be configured to close on torque for seating valve types or limit for non-seating valve types.

⚠ Refer to Valve manufacturer for recommended setting. In the absence of valvemaker instruction refer to the following table.

Valve Type	Close Action	Open Action
Wedge gate	Torque	Limit
Globe	Torque	Limit
Butterfly	Limit	Limit
Through Conduit	Limit	Limit
Ball	Limit	Limit
Plug	Limit	Limit
Sluice gate	Limit	Limit
Penstock	Limit	Limit
Parallel Slide	Limit	Limit

Press to select Close Action function. Use or to check required setting. Press to set.

3 / 15 Close Torque

The value of torque available to close the valve can be set between 40% and 100% of rated. The actuator rated torque value is shown on its nameplate.

Press to select Close Torque function. Use key to decrease value and key to increase value.

Press key to set.

4 / 15 Set Close Limit

Press to select Close Limit Function. The actuator will display the following instruction:

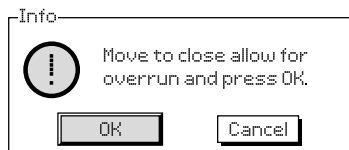

Move the actuator and valve to the close position. Allow for overrun by winding open by 1/2 to 1 turn of the handwheel.

Press to set the close limit position.

5 / 15 Open Action

The actuator can be configured to open on torque for seating valve types or limit for non-seating valve types.

⚠ Refer to Valve manufacturer for recommended setting. In the absence of valvemaker instruction set open action to "Limit".

Press to select Open Action function. Use or to check required setting. Press to set.

6 / 15 Open Torque

The value of torque available to open the valve can be set between 40% and 100% of rated. The actuator rated torque value is shown on its nameplate.

Press to select Open Torque function. Use key to decrease value and key to increase value.

Press to set.

7 / 15. Set Open Limit

Press to select Open Limit Function. The actuator will display the following instruction:

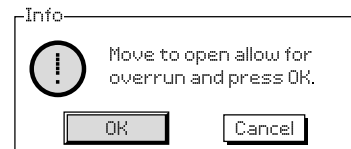

Move the actuator and valve to the open position. Allow for overrun by winding closed by 1/2 to 1 turn of the handwheel.

Press to set the open limit position.

8 / 15. Turns (not editable)

Shows the actuator output turns between the set Closed and Open limit positions.

9 / 15. Position (not editable)

Shows the actuator current position in terms of % open.

Note: Turns and Position values do not update while being displayed on screen. To see updated values, use key to return to Settings Menu, then select Limits.



4.6.1 Verify Valve Operation (If the Process Allows)

Turn the red selector to LOCAL. Using the black selector, turn to the Close position and make sure the valve runs to the fully closed position. Check the correct seating action has occurred and the valve is fully shut.

Using the black selector, turn to the Open position and make sure the valve runs to the fully opened position. Check the correct seating action has occurred and the valve is fully open.

Return to Positional Display

Select REMOTE control using the red selector to exit setting procedure. If the procedure has been followed as described, the display will indicate open limit position (100%). Select Stop control.

4.7 Secondary Commissioning – Indication Settings

Note: Indication outputs S1 to S4, Monitor Relay and the CPT analogue position signal do not fall within the scope of the actuator reliability assessment. User must ensure the integrity of indication meets the requirements of the SIL target for the SIS. If necessary, position indication should be derived from devices external to the actuator and driven directly from the valve obturator.

Fault Status Relay

The SIL control board includes a fault status indication relay. For Safety Function fault status indication refer to tables 2.1 & 2.2. The relay will de-energise and contacts break on indication of a fault condition that affects the actuator's ability to perform the Safety Function. The status relay is not configurable. Refer to supplied circuit diagram for connection details.

Monitor Relay

The monitor relay will indicate one or more of the following conditions:

- Loss of one or more of the power supply phases
- Loss of control circuitry supply
- Actuator selected for Local control or Local Stop*
- Thermostat tripped
- Compromised SIL action

*The monitor relay is configurable for Availability or Fault. If set to fault, the monitor relay will ignore the position of the Local / Stop / Remote selector. Refer to actuator circuit diagram for connections.

Compromised SIL action is defined as a situation where the SIL action is performed for the configured run time due to a fault with the position or torque sensor.

Contacts S1-S4

The actuator has 4 configurable contacts, S1 to S4 available for indication including open and closed position limit indication and intermediate position indication (configurable). A full list of available functions is provided in publication PUB002-040.

Unless specified with order, contacts S1 to S4 will be set to the default shown below:

Contact	Function	Contact
S1 [r1]	[CL] - Closed Limit	[NO] - Normally Open
S2 [r2]	[OP] – Open Limit	[NO] – Normally Open
S3 [r3]	[CL] - Closed Limit	[NC] – Normally Closed
S4 [r4]	[OP] – Open Limit	[NC] – Normally Closed

If fault coverage is required the 4 configurable relays can be set to operate as follows:

- Close limit
- Open limit
- Centre column rotating (indicates when the actuator is moving).
- Torque switch tripped (indicates the actuator has torque tripped mid travel and failed to reach the limit position).

Option CPT

If the CPT option is fitted a 4-20 mA signal is available for analogue position indication - refer to actuator circuit diagram. On loss of main actuator power supply, the CPT output will default to 0 mA regardless of actuator position.

4.8 Secondary Settings – ESD

If Safety Function 2 (ESD) is required then you must disable the normal actuator ESD to prevent operation during the setup procedure. Navigate to the **CONTROL > ESD** menu, then in the ESD mode press **⏏** to access the drop down list. Select **OFF** and press **⏏** to accept.

4.9 Secondary Settings – Remote Maintain (SF1 only)



When Safety Function 1 is required, the permissive signal is applied using the remote maintain input terminal 34, which is remapped to become the Motor Enable input.

To keep the maintained / non-maintained feature during the remap, the user can select whether or not the remote control signals are self-maintained when the Motor Enable signal is present.

Navigate to the **CONTROL > REMOTE > HARDWIRED** menu:

Remote Control	
2-Wire Priority	Stop ▼
Interlocks	
Mode	Disabled ▼
Motor Enable	
Motor Enable	Push to Run ▼
▲▼ ⏏ 3/3	

Remote Control	
2-Wire Priority	Stop ▼
Interlocks	
Mode	Disabled ▼
Motor Enable	
Motor Enable	Disabled
	Push to Run
	Maintained
▲▼ ⏏ 3/3	

Navigate to the Motor Enable setting and press the **⏏** key. From the drop down list select if Push to Run or Maintained control is required. Press the **⏏** key to accept the setting.

The following procedures must be followed in order. **Mandatory settings if indicated must not be changed. Configurable safety function settings must be set as required for the SIS.**

The setting tool is provided to make settings. For instructions on its use refer to section 4.3 or section 8 in PUB002-039.

The actuator can be setup to function as required by following the instructions set out in PUB002-040. Standard actuator functions are available and do not affect the Safety Function.

If Safety Function 2 is required, then you must ensure the ESD (Normally Closed) signal is present. If the system ESD signal is not available, a temporary signal can be provided by linking actuator terminal 5 to 25 and terminal 4 to 31 to prevent the Safety Function from operating once it has been setup. It is important that this bypass link is removed after commissioning has been completed.

5.1 General Safety Function Settings

Refer back to the section for each Safety Function setup for instructions on how to access the SIL menu and initiate the setup mode.

NOTE: Any changes to the Safety Function settings will disable SIL mode and place the actuator into SIL Config mode. You must complete the setup, perform a configuration run and activate SIL in order for the Safety Function to be available. The status of Safety Function availability can be read from the Fault Status relay (section 4.6).

Make sure the red selector is set to LOCAL CONTROL.

Connect to the actuator using the supplied *Bluetooth* Setting Tool, refer to section 4.3

Navigate to the CONTROL > SIL menu:

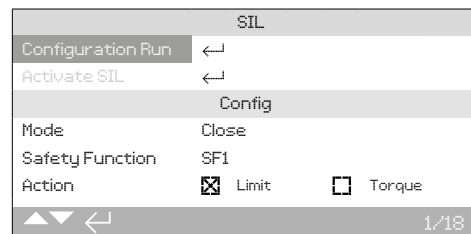
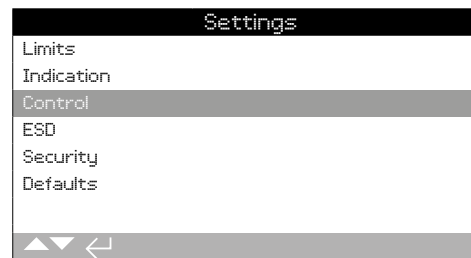

Using navigate to the Safety Function in the Configuration section and press . The Password prompt will appear:

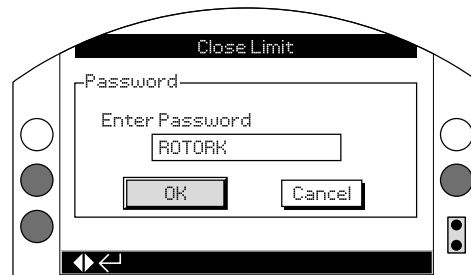

The high level password will be required to make any changes. Refer to PUB002-039 for instructions on entering the password. The high level password to make changes is:

ROTACT

Once entered, press the key to accept the password and the following prompt will appear:

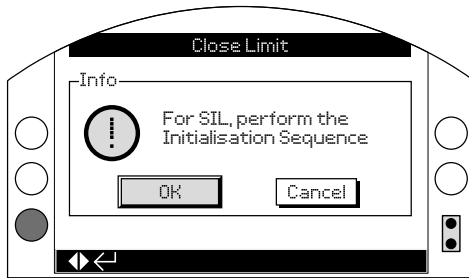

Perform the Initialisation Sequence (within 20 seconds) on the Red Selector to activate the menu. Ensure no more than 5 seconds elapses between each **LOCAL** and **STOP** movement otherwise the initiation will have to be re-started:

STOP – LOCAL – STOP – LOCAL – STOP – LOCAL

Changes can now be made to the SIL configuration. SIL Config Mode will be displayed in the message bar at the top of the display and SIL will become deactivated.

Below is a full list and description of the available settings:

SIL Settings		Description
Set Configuration		Sets the current config to memory and (for SF2 only) initiates a test run.
Activate SIL		Activates the SIL status relay to indicate the Safety Function is set and activated.
Configuration Settings		
Safety Function	SF1/SF2/Both	Safety Function to be carried out. SF1 (stayput), SF2 (ESD) or a combination of both Safety Functions.
Priority	SF1/SF2	Used for a combination of both SF1 & SF2. Sets which Safety Function takes priority.
SF2 Action	Open/Close/Stayput	Used for SF2 only. Sets which ESD action is performed on removal of the ESD signal.
Seating	Limit/Torque	Used for SF2 only. Sets the seating action of the valve when performing the Safety Function.
Override Local	On/Off	Used for both SF1 & SF2. Allows the Safety Function to be carried out when the actuator is set to LOCAL control.
Override Stop	On/Off	Used for SF2 only. Allows the Safety Function to be carried out when the actuator is set to STOP.
Override Stop/Err	On/Off	Used for SF2 only. Allows the Safety Function to be carried out when the local controls have failed or detects an invalid local control signal.
SIL Hold Off Time	0-3600 seconds	Used for SF2 only. Sets the time to delay the SF2 action when the ESD signal is removed.
Run Time	0-3600 seconds	Shows the time taken to perform the SF2 action for a full stroke. Editable should the ESD operating time need to be adjusted to accommodate for process deviation.
Interrupter Timer		
Copy Settings		Used for SF2 only. Press to copy the existing Interrupter timer settings from the actuator's non-SIL menu to utilise the same operation. Alternatively different operational timer settings can be used during the Safety Function.
Enabled	On/Off	Used for SF2 only. Enable the Interrupter timer for the Safety Function.
Start	Open/Close	Used for SF2 only. Direction that the Interrupter Timer will start or stop operating.
Closing	0%-100% position	Used for SF2 only. Position in the closing direction, from the start limit, that the Interrupter Timer will be active.
Opening	0%-100% position	Used for SF2 only. Position in the opening direction, from the start limit, that the Interrupter Timer will be active.
On Time (s)	0-255 seconds	Used for SF2 only. Time that the contactor is energised for each ON period.
Off Time (s)	0-255 seconds	Used for SF2 only. Time that the contactor is de-energised for each OFF period.

The following sections explain the setup procedure for each type of Safety Function and / or combination of Safety Functions.

Safety Function 1 (stayput) is achieved by the application of a permissive signal in order to allow any remote operation. The permissive signal must be applied (nominal 24 VDC) to the Motor Enable input (terminal 34) to allow operation, refer to the wiring diagram supplied.

Gain access to the SIL menu and Safety Function settings as per section 5.1.

Navigate to the **Safety Function** setting and press **↵**:

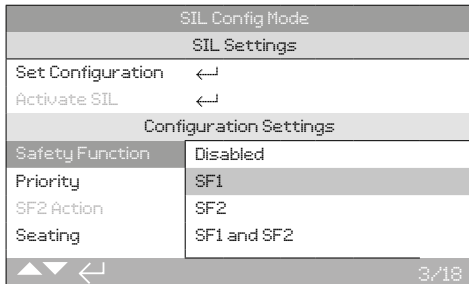

Using the **↶** **↷** arrow keys, select the desired Safety Function, in this case SF1. Press the **↵** key to accept. SF1 will be displayed.

The **ESD MODE**, **ACTION** and **PRIORITY** settings do not need to be configured for Safety Function 1 only. The settings will be ignored.

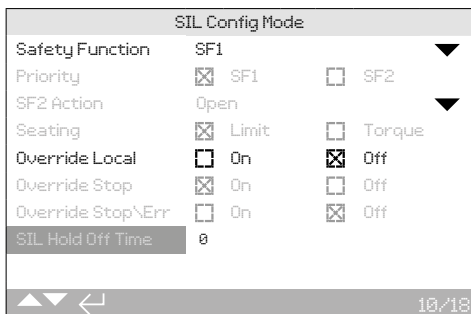

Using the **↶** arrow key, navigate to the overrides section and set the values as required. For SF1 the only overrides that might be required are:

- **Override Local** – if selected, the permissive input will be required for local operation in addition to remote operation

Once all settings have been entered, set the actuator to **LOCAL** control mode and perform the **SET CONFIGURATION** function.

Use the **↶** **↷** arrow keys to navigate back to the top of the menu and highlight **SET CONFIGURATION**. Press the **↵** key to commit the current SIL configuration to non-volatile memory. Once this has been carried out the actuator Safety Function is ready to be verified.

NOTE: It is the responsibility of the installer / user / integrator to verify the Safety Function is correctly set and functions as expected*.

Once verification has been carried out, use the **↶** arrow to highlight the **ACTIVATE SIL** function and press the **↵** key to activate the SIL status relay. This is the external confirmation the Safety Function has been configured and activated.

To return to the main actuator positional display, press the **↶** **↷** arrow keys at the same time.

The actuator's Safety Function is now ready for use.

*** Verification of the configured Safety Function should be performed in all applicable operating modes. Testing in remote will exit the SIL configuration mode and requires the user to access the SIL settings again. Follow instructions in section 5.1 to gain access to the menu and proceed with activating SIL.**

Safety Function 2 (ESD) is achieved by the removal of a permanent signal in order to allow ESD (Emergency Shut Down) operation. The action can be either to **OPEN**, **CLOSE** or **REMAIN IN POSITION** (stayput)*. The ESD signal must be removed from the ESD input (terminal 25) to allow operation, refer to the wiring diagram supplied.

* Not to be confused with SF1 (Stayput) as these are different safety functions.

Gain access to the SIL menu and Safety Function settings as per section 5.1

Navigate to the **Safety Function** setting and press **OK**:

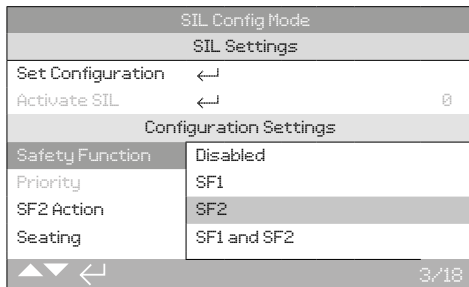

Using the **Left/Right** arrow keys, select the desired **Safety Function**, in this case SF2. Press the **OK** key to accept. SF2 will be displayed.

Priority setting not required for SF2 only.

Using the **Left/Right** arrow keys, select SF2 Action and press the **OK** key to highlight the setting. Using the **Left/Right** arrow keys select the desired ESD action from the list. This is the action that will be carried out when the Safety Function is initiated by removal of the ESD input on terminal 25. Press the **OK** key to accept.

Using the **Left/Right** arrow keys, select Seating and press the **OK** key to highlight the setting. Use the **Left/Right** arrow keys to select the correct seating action for Safety Function 2. The setting required will depend on the valve type. Refer to the valvemakers recommended setting. Press the **OK** key to accept.

The following settings are optional depending on operational requirements of the SIS.

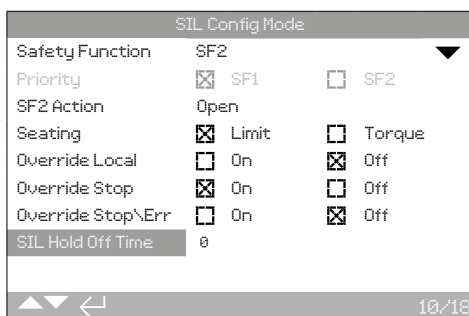

Using the **Left/Right** arrow keys, navigate to the overrides section and set the values as required.

- **Override Local** – if set to on, SF2 action will override when Local control is selected.
- **Override Stop** – if set to on, SF2 action will override when local Stop is selected.
- **Override Stop / Err** – if set to on, SF2 action will override Stop or Local control error.
- **Hold Off Time** – if set to anything other than 0 seconds, a delay will be introduced between the ESD signal being removed and the Safety Function being performed.

Once all settings have been entered, set actuator to **LOCAL** control mode and move the actuator to the non SIL end of travel position. Make sure the actuator is run to the end of travel that is opposite to the final Safety Function position. E.g. if the Safety Function SF2 action is to close the valve, make sure you run to the fully open position.

Use the **Left/Right** arrow keys to navigate back to the top of the menu and highlight **SET CONFIGURATION**. Press the **OK** key and the following warning will appear:

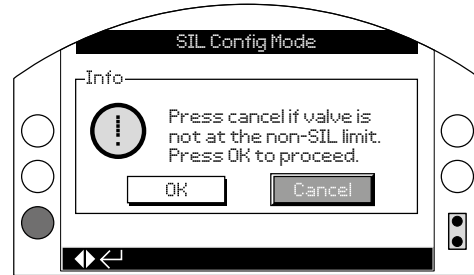

WARNING: On pressing the **OK** key, the actuator will perform a Set Configuration to learn the stroke time. Make sure it is acceptable for the actuator / valve to move before pressing OK. Setting tool commands are restricted during this process.

Press the **OK** key to select OK then press the **OK** key to commit the current SIL configuration to non-volatile memory and start the Set Configuration. The actuator will run to the final SIL position and display a "please wait" dialog during this process. Setting tool commands are restricted during the Set Configuration. Once this has been carried out the actuator Safety Function is ready to be verified.

NOTE: It is the responsibility of the installer / user / integrator to verify the Safety Function is correctly set and functions as expected**.

****Verification of the configured Safety Function should be performed in all applicable operating modes. Testing in remote will exit the SIL configuration mode and requires to the user to access the SIL settings again. Follow instructions in section 5.1 to gain access to the menu and proceed with activating SIL.**

WARNING: The stroke time should be independently verified by measuring the time it takes to perform the full SIL stroke***. The stroke time should be cross checked against the Run Time value in the SIL Configuration Settings. If there is a discrepancy, re-run the Set Configuration process after moving to the non-SIL limit. If the user wishes to deviate from the set Run Time for operational conditions, highlight the Run Time value and adjust as required.

***** For applications that use the Interrupter Timer during the SIL stroke, please refer to the Interrupter Timer settings section 5.6 for advice.**

Once verification has been carried out, use the **Left** arrow to highlight the **ACTIVATE SIL** function and press the **OK** key to activate the SIL status relay. This is the external confirmation the Safety Function has been configured and activated.

To return to the main actuator positional display, press the **Left/Right** arrow keys at the same time.

The actuator's Safety Function is now ready for use.

In some cases the user may require both SF1 and SF2. This section describes the case where SF1 (stayput) has the highest priority.

For SF2 (removal of the ESD signal from terminal 25) to be carried out, you must first apply a permissive signal to the Motor Enable input (terminal 34).

Refer to Sections 5.1, 5.2 and 5.3 to set up each Safety Function.

Navigate to Safety Function and press the key to open the drop down menu. Use the arrow keys to select SF1 & SF2.

Navigate to Priority and press the key to highlight the setting. Use the arrow keys to select SF1. Press the key to accept the change. It is important to remember that SF1 will prevent and interrupt any operation if it is configured as the priority signal. Verification testing should involve various input combinations for SF1 and SF2. Results should match the table shown in section 2.1 and 2.2 when SF1 is removed or applied respectively.

Once verification has been carried out, use the arrow to highlight the **ACTIVATE SIL** function and press the key to activate the SIL fault status relay:

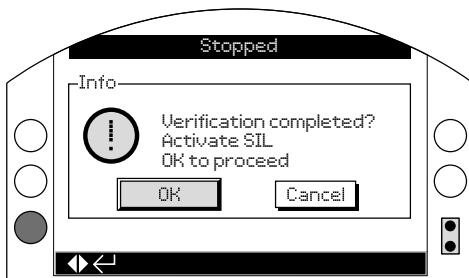

The SIL fault status relay is the external confirmation the Safety Function has been configured and activated. To return to the main actuator positional display, press the arrow keys at the same time. The actuator's Safety Function is now ready for use.

In some cases the user may require both SF1 and SF2. This section describes the case where SF2 (ESD) has the highest priority.

SF1 will always prevent normal remote operation, with the exception of the SF2 (ESD). In all cases SF2 will activate the ESD safety Function, despite the status of SF1.

Refer to Sections 5.1, 5.2 and 5.3 to set up each Safety Function.

Navigate to Safety Function and press the key to open the drop down menu. Use the arrow keys to select SF1 & SF2.

Navigate to Priority and press the key to highlight the setting. Use the arrow keys to select SF2. Press the key to accept the change. It is important to remember that SF2 will interrupt any operation if it is configured as the priority signal. Verification testing should involve various input combinations for SF1 and SF2. Results should match the table shown in section 2.2 and 2.1 when SF2 is removed or applied respectively.

⚠ WARNING: If the actuator is physically disconnected from the power supply, the Safety Function setup procedure must be carried out when reconnection takes place. A power cycle will not require any reprogramming.

⚠ WARNING: If the actuator is mechanically removed from the valve, the Safety Function setup procedure must be carried out when it is replaced.

The SIL fault status relay output signal is de-activated when the actuator is in commissioning mode. This is reset when the Safety Function is configured and activated ready for use.

The Interrupter Timer (IT) for SIL SF2 (ESD) can be configured to operate separately from the standard Interrupter Timer, so can be set to perform the same IT profile or a different profile during the SIL ESD stroke. The SIL Interrupter Timer feature is included as standard, but the standard IT may be optional.

For ease of setting, the standard IT settings can be copied into the SIL configuration settings with one button.

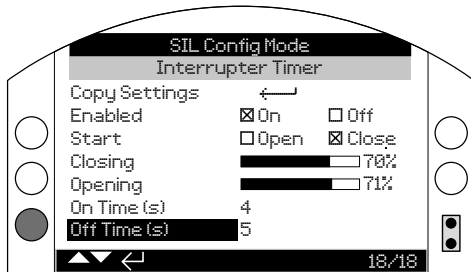

Copy Settings – Use this feature to copy the standard IT settings. Only use this if the same IT profile is required during the SIL ESD stroke. Using the **←** and **→** arrow keys, highlight Copy Settings and press the **⏎** key. Once this has been completed, follow the instructions for setting a configuration and activating SIL in section 5.3

For applications that require a different IT profile during the SIL ESD stroke, or for units that do not use the IT feature during normal operation, but require it for the ESD stroke, follow the instructions below:

Enabled – Navigate to the **Enabled** menu item and press the **⏎** key to highlight. Using the **←** and **→** arrow keys to select **ON**, press the **⏎** key to accept the setting.

Start – The IT profile will operate between the Start limit position and the relevant direction (Closing or Opening) position. If the safety function is to **CLOSE** on ESD and Start is set for **CLOSE**, then the IT profile will function between the Closing position and 0% during the SIL action. Alternatively, if the safety function is to **CLOSE** on ESD and Start is set for **OPEN**, then the IT profile will function between 100% and the Closing position. Use the **←** and **→** arrow keys to navigate and press the **⏎** key to highlight. Use the **←** and **→** arrow keys to select the correct direction and press the **⏎** key to accept. Refer to figure 5.1 for IT profile operating span.

Closing – This is the position which the IT profile will start to operate in the closing direction. If the ESD function is to **OPEN** then ignore this setting. Use the **←** and **→** arrow keys to navigate and the **⏎** keys to select the value. Refer to figure 5.1 for IT profile operating span.

Opening - This is the position which the IT profile will start to operate in the opening direction. If the ESD function is to **CLOSE** then ignore this setting. Use the **←** and **→** arrow keys to navigate and the **⏎** keys to select the value. Refer to figure 5.1 for IT profile operating span.

On Time – This is the time the motor will be operating for each IT pulse. Use the **⏎** and **⏎** keys to adjust.

Off Time – This is the time the motor will idle for each IT pulse. Use the **⏎** and **⏎** keys to adjust.

Once the settings have been completed successfully, return to Section 5.3 and follow the procedure for setting a configuration and activating the SIL feature.

NOTE: Part of the verification is to time the stroke time and compare it to the RUN TIME in the SIL configuration settings. When using the Interrupter Timer feature, the RUN TIME will only show the time that the motor is operating (On Time) and not the idle time (Off Time), so take this into account when comparing the measured and calculated times.

It is important that actuator operation is verified to ensure the required safety function is achieved. In order to confirm actuator operation with the valve working under design conditions, it is desirable that the process is live during verification. Remote Open / Close and/or ESD / Motor Enable control circuits should be wired and available. Refer to actuator circuit diagram.

The IQ3 actuator includes a datalogger which records operational torque reference profiles for analysis of valve performance.

6.1 Valve Setting Verification

1. Power up the actuator and select local control.
2. Operate the actuator in both open and close directions. Ensure the actuator operates the valve fully to each end of travel and the valve is positioned or seats correctly with the set action (torque or limit). If necessary, adjust basic settings, refer to section 4.2

Torque profiles may be downloaded for analysis of actuator torque switch settings against operating torque requirements, refer to PUB002-040.

The SIL Interrupter Timer will operate throughout the shaded area of travel in the SF2 Action direction.

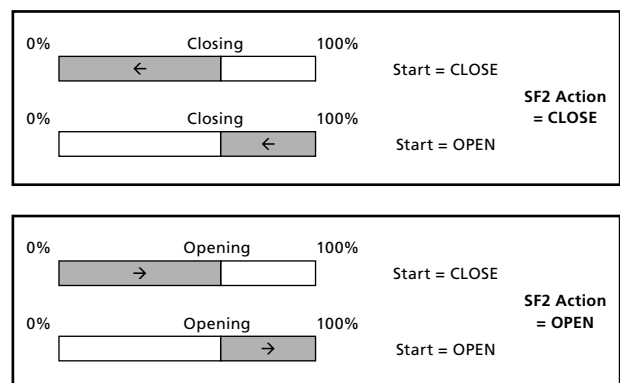

Fig 5.1.



6.2 Safety Function 1 - Stayput Verification

Power up the actuator. Set the control selection and apply input signals as indicated in the following table to validate that the actuator will stayput unless the correct control selection is made and 2 valid signals are applied (open/close and motor enable):

SF1					
Override Local	Control Mode	Applied Signal	Motor Enable Input	Action	SIL Relay Contact
On	Local/Remote	Open/Close	Applied	Local/Remote Operation	Closed
On	Local/Remote	Open/Close	Removed	No Operation	Closed
Off	Local	Open/Close	Applied	Local Operation	Open
Off	Local	Open/Close	Removed	Local Operation	Open
Off	Remote	Open/Close	Applied	Remote Operation	Closed
Off	Remote	Open/Close	Removed	No Operation	Closed

Table 6.2

Check the relay status conforms to the table. Failure to replicate status as shown in the table indicates an error in the commissioning procedure, the control signal status or control selection and must be corrected.

6.3 Safety Function 2 - ESD Setting Verification

Set the control selection and apply input signals as indicated in the following table to validate that the actuator will perform the set ESD action (Open, Close or Stayput) when the ESD signal is removed and Local or Remote is selected:

SF2						
Override Local	Override Stop	Control Mode	Applied Signal	ESD Input	Action	SIL Relay Contact
On	On	Local/Stop/Remote	Open/Close	Removed	Configured ESD	Closed
On	Off	Local/Remote	Open/Close	Removed	Configured ESD	Closed
On	Off	Stop	Open/Close	Removed	No Operation	Open
Off	On	Stop/Remote	Open/Close	Removed	Configured ESD	Closed
Off	On	Local	Open/Close	Removed	Local Operation	Open
Off	Off	Local	Open/Close	Removed	Local Operation	Open
Off	Off	Stop	Open/Close	Removed	No Operation	Open
Off	Off	Remote	Open/Close	Removed	Configured ESD	Closed

Table 6.3

Check the relay status conforms to the table. Failure to perform or indicate as shown in the table indicates a problem in the commissioning procedure, the control signal status or control selection and must be checked.

6.4 Proof Testing – Safety Function 2 - ESD

To meet certification requirements for low demand ESD safety function 2, full operational proof testing must be carried out at least once per year.

The IQ3 actuator includes a datalogger which records operational torque reference profiles for analysis of valve performance. Proof test torque profiles may be downloaded for analysis of operating torque requirements, refer to PUB095-001.

6.4.1 Proof Testing – Safety Function 2 – ESD – Open Close



Move actuator to the end of travel that is opposite to the final Safety Function position. Select Remote control.

Remove system ESD signal. Actuator will move to ESD position. Verify the action has completed successfully and re-apply system ESD signal. Verify that the SIL relay contacts are closed.

With Remote control selected, apply valid Remote Open or Close signals. The actuator will move in the applied signal direction. While moving, remove the ESD signal on terminal 25. The actuator should stop without displaying error or status relay fault.

6.4.3 PFD verses powered operation testing

Proof testing (SF2 open or close) is set to at least once per year to verify operation and must consist of a full stroke test.

The Probability of Failure on Demand figure can be reduced by performing a powered operation at regular intervals. A powered operation can be either an automatic partial stroke or PVST (standard open or close commands in either Local or Remote).

Below is a table and graph showing the relationship between PVST and PFD figures.

Months	Hours	Size 1	Size 2	Size 3	Size 4	Size 5
1	730	9.95E-04	1.15E-03	1.10E-03	1.03E-03	1.46E-03
2	1460	1.58E-03	1.82E-03	1.75E-03	1.64E-03	2.32E-03
3	2190	2.17E-03	2.49E-03	2.39E-03	2.25E-03	3.18E-03
4	2920	2.75E-03	3.17E-03	3.04E-03	2.86E-03	4.04E-03
5	3650	3.34E-03	3.84E-03	3.69E-03	3.46E-03	4.90E-03
6	4380	3.92E-03	4.52E-03	4.34E-03	4.07E-03	5.76E-03

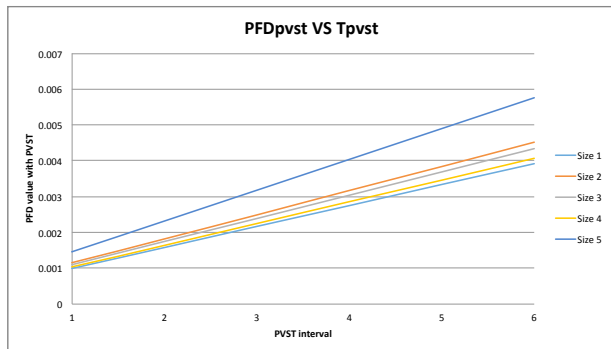

Size	Actuator
1	IQ10, 12 or 18
2	IQ19, 20 or 25
3	IQ35
4	IQ40
5	IQ70, 90, 91 or 95

7. Tamper Prevention

IQ3 operation is generally described in publication PUB002-039.

When operating as part of the SIS the actuator is intended to be operated only by remote control and therefore should be selected and locked in "Remote". Overrides for Local control and Stop can be applied to ensure Safety Function operation is possible in these modes as well. Handwheel operation should also be prevented. Padlocks with a 6 mm / ¼" hasp should be used to padlock the red selector in the "Remote" position and the Hand-Auto lever in the neutral "up" position. Refer to figure 7.1 and 7.2. These settings should be subject to the site operational procedures such as "permit to work".

⚠ WARNING: If during commissioning, maintenance or testing the actuator is operated by the handwheel it is vital that it is returned to motor drive before the actuator is put back into operational service. To do this the actuator must be operated electrically and electrical operation verified by checking output movement. The hand auto lever must then be padlocked in the neutral "up" position.



Fig 7.1. IQ3 hand-auto lever padlocked



Fig 7.2. IQ3 control selector padlocked in "Remote"

Refer also to publication PUB002-039 for essential health and safety information.

When maintenance is to be carried out on or around an actuator it is essential that the actuator is electrically isolated to prevent unwanted operation.

Check the actuator oil level once per year. Refer to publication PUB002-039.

⚠ WARNING: Isolate the actuator power supply before any work is carried out on the actuator, valve or associated system equipment or processes.

⚠ WARNING: The actuator may operate without warning and regardless of remote signal status.

⚠ WARNING: The actuator is designed to perform the set Safety Function (Open, Stayput or Closed) under system ESD conditions.

⚠ WARNING: The set Safety Function can be configured to operate in LOCAL and/or STOP so neither mode can guarantee no operation.

rotork®

Keeping the World Flowing



www.rotork.com

A full listing of our worldwide sales and service network is available on our website.

UK
Rotork plc
tel +44 (0)1225 733200
fax +44 (0)1225 333467
email mail@rotork.com

USA
Rotork Controls Inc.
tel +1 (585) 247 2304
fax +1 (585) 247 2308
email info@rotork.com

Rotork is a corporate member of the Institute of Asset Management



PUB002-057-00
Issue 07/17

As part of a process of on-going product development, Rotork reserves the right to amend and change specifications without prior notice. Published data may be subject to change. For the very latest version release, visit our website at www.rotork.com

The name Rotork is a registered trademark. Rotork recognises all registered trademarks. The Bluetooth® word mark and logos are registered trademarks owned by Bluetooth SIG, Inc. and any use of such marks by Rotork is under license. Published and produced in the UK by Rotork Controls Limited. POWTG0717